

HD 1080P Wireless Security Wi-Fi Camera

User Manual
Version: Aug, 2019

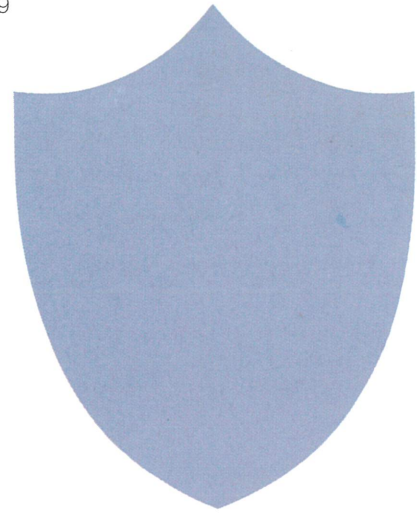

Size: 46x46x74mm



Tiny Light (no battery)



Size: 145x16x87mm



Weather Clock

Overview:

The wireless Wi-Fi security camera comes with HD 1080P high resolution camera for live video streaming worldwide from anywhere by smartphone APP TinyCam; The USB wall lamp one is worked by hand and by remote controller ; And the Weather forecast Clock works with powerful invisible 6M night vision for day and night.

Usages: Nanny camera, Home/ Shop/ Office/ Warehouse surveillance camera.....

Warning : " illegal use is not allowed! Or, there will be consequences to bear! "

In the box:

- 1 x Camera Unit
- 1 x 5V2A power adapter
- 1 x Micro SD Card Reader
- 1 x USB Cable
- 1 x User Manual

Product structure of Tiny Light:

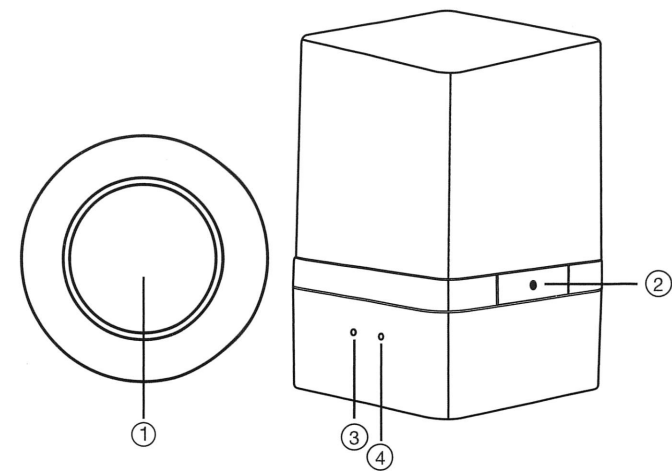

- ① Remote controller: Long press to Off, one click to On, double click for brightness
- ② Camera
- ③ Wi-Fi indicator
- ④ Reset hole

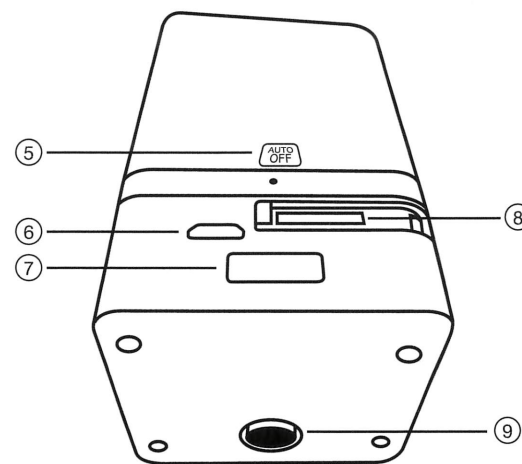

- ⑤ Light ON/OFF button(Long press to Off, one click to On, double click for brightness)
- ⑥ USB port -1
- ⑦ USB port -2
- ⑧ Micro SD card slot
- ⑨ USB out/in button

Product structure of Weather Clock:

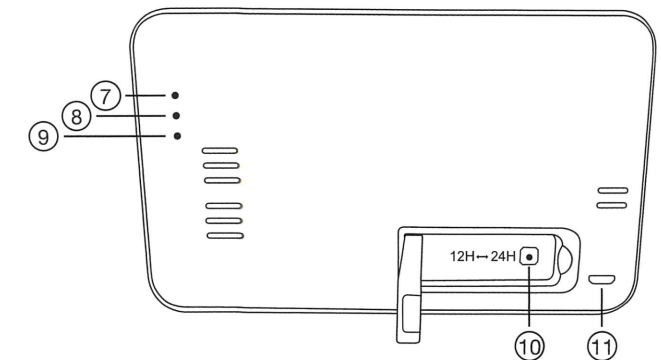
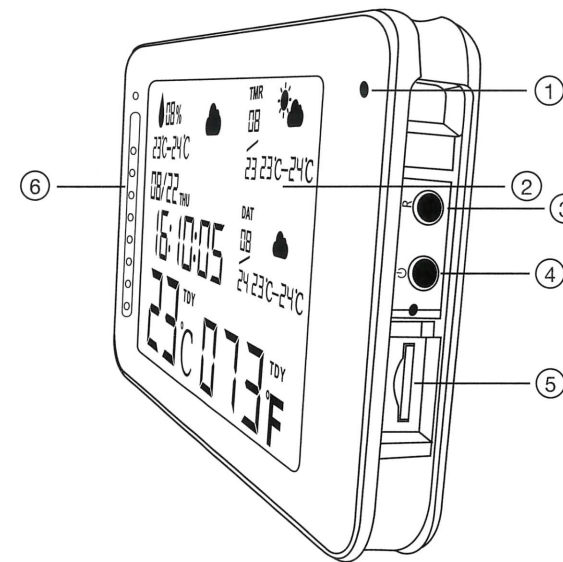

- ① Camera
- ② 5 inch display screen
- ③ Reset key
- ④ ON/OFF key
- ⑤ Micro SD card slot
- ⑥ Night vision lights
- ⑦ Charging indicator
- ⑧ Wi-Fi indicator
- ⑨ Power indicator
- ⑩ 12H/24H: Long press to turn on/off screen display
- ⑪ USB port

Tips: The time and temperature will be updated automatically every 2 hours after Wi-Fi connection.

Wi-Fi Camera Connection Setting

Step1: Download and install APP

Scan below QR code or search and download free APP named <TinyCam> in Apple APP store, Google play or Electronic market, and install it;

Tips: Please allow "TinyCam" to access your location while you are using the app(for syncing local weather info).

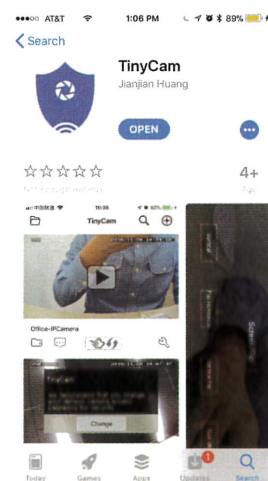

Step 2: Insert micro SD card --> Plug in devices with included power adapter --> Press back ON/OFF switch for 2 seconds , wait for 1 minute (Power indicator and Wi-Fi indicator is solid green.);

Step 3: Connect Wi-Fi

1. Open smartphone settings, search and connect the device's wireless signal named "HCAM.....", wait Wi-Fi connected, and phone status bar appear Wi-Fi symbol.

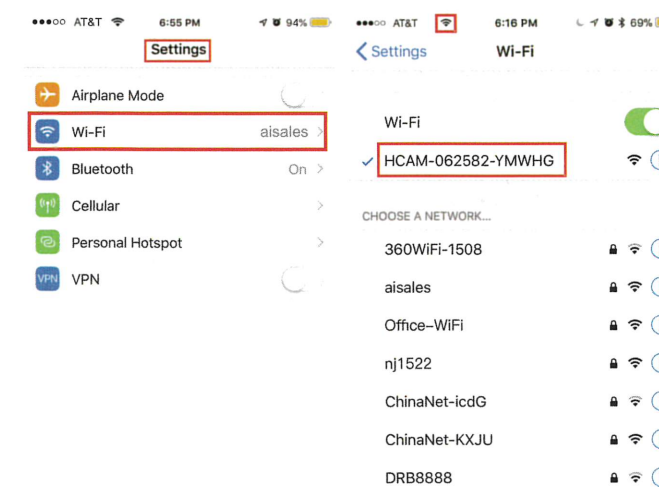

2. Enter APP, press right corner "Q" icon --> LAN search device --> Press Add --> Camera Online then;

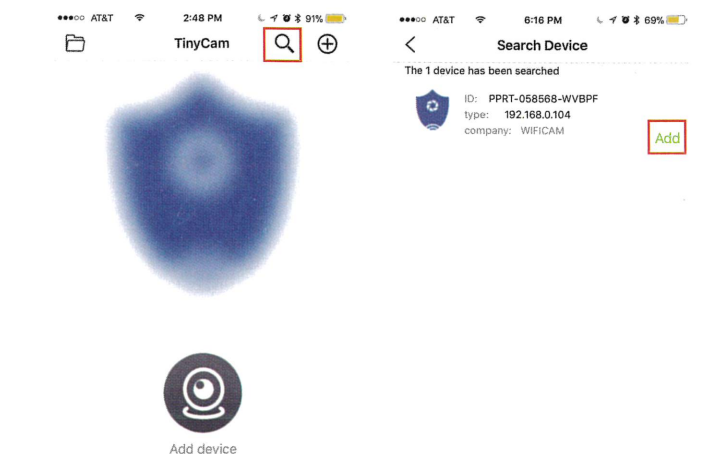

Tips: 1. Please select **[Change]** to change device password for security **[default: 888888]** ;
2. This step = P2P mode, can check video locally when without Wi-Fi.

3. Press  icon on the right corner of camera --> WiFi Config --> Select local Wi-Fi (SSID) --> Input password --> Press Confirm;

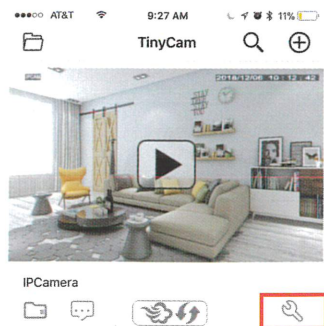

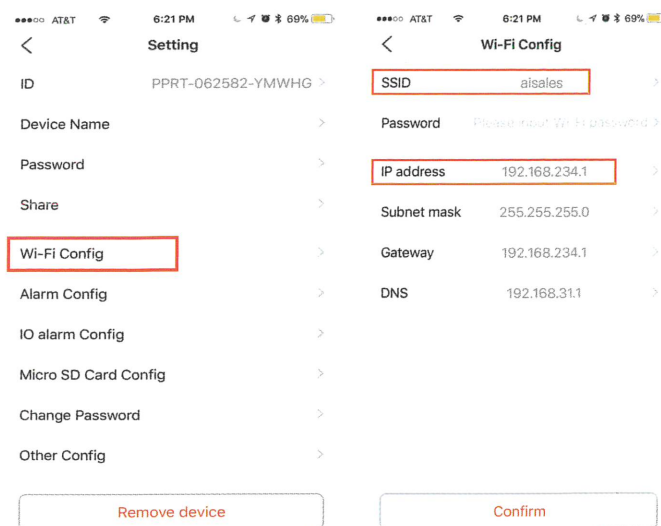

11



4. Quit APP , wait 30 seconds (device restart automatically) and connected with set Wi-Fi (Wi-Fi indicator flash regularly) ;
5. Enter APP and check live video locally or remotely anywhere.

12

Set camera name and private code

Set name: Press the  after the camera, select Device name --> Input needed name or select sample names like Office...
Set new password: Press the  after the camera, select Change Password --> Old password = 888888.

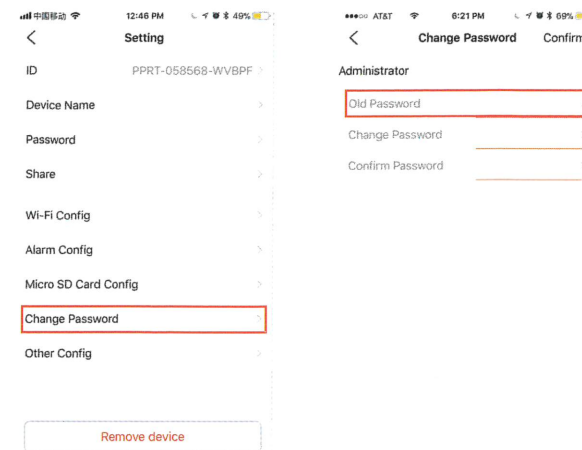

13

APP introduction:

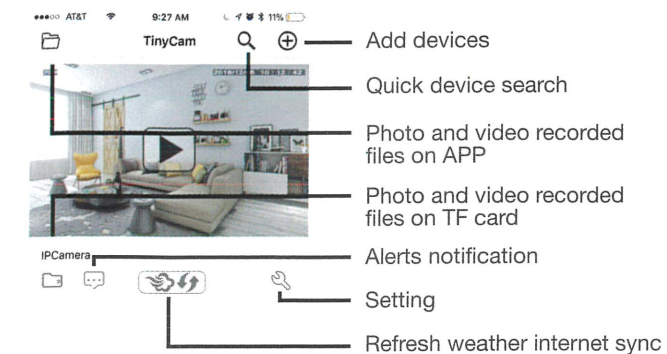

Tips: 1. Please confirm phone setting has allowed TinyCam App to access the location services;
2. A TF card (Micro SD card) must be inserted for saving alerts pictures.

14



Resolution (1080P/720P/640P/480P, 1080P=Highest resolution)

Alerts notification

Full screen

Listen

Talk

Snapshot Record Videos

15

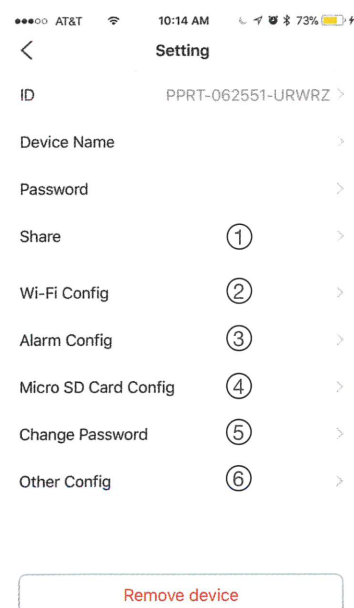

- ① Share camera with others by QR code
- ② Wi-Fi Config: Set camera to connect to local Wi-Fi
- ③ Alarm Config: Set motion detection sensitivity / Alarm interval
- ④ Micro SD Card Record Config: Set SD card record mode / Resolution / File length...
- ⑤ Change password: Set camera new password
- ⑥ Other Config: Time Config, Device reset, FTP or Mail setting...

Remove device

16

Watch by PC in LAN network

Once camera connected well with Wi-Fi, press the  after the camera, Wi-Fi Config --> find out IP address --> Input this IP address info into browser.
User name: admin Password: your set password (default 888888)

Watch by PC remotely (WAN)

Once camera connected well with Wi-Fi, download PC driver from below QR code.
Input UID, User name: admin Password: your set password (default 888888) for checking live streaming video remotely.



17

Specification

Resolution	1 Mega CMOS
Video pixel in phone	Max 1920*1080
Video pixel in card	1080*720
Frames	Max 25fps
Compressed format	H.264
View angle	120 Degree
Type of memory card	TF card >= Class 4/10 and HC marked
Maximum capacity of memory card	128GB
PC operation system	Windows 7, 8 / Mac OS X
Play software	VLCPlayer/SMPlayer
Mobile phone operation system	Android/iOS
Web browser	IE7 and above, chrome, firefox
Power consumption	300MA/3.7V
Battery Capacity	Rechargeable 1800 mA
Recording	1 minute/ around 20MB
Working time in day time	Around 4-5 hours
Working time in night time	Around 2-3 hours
Charging time	3-4 hours
Power adapter	5V / 2A

18

FAQ

1. Q: Time display is not stable, always blinking?
A: It's with low battery, please charge it.
2. Q: Can't get device Wi-Fi signal? (Five solutions FYI).
A: Press reset key for 10 seconds and wait 1 minute.
3. Q: Live video not smooth and clear?
A: Select suitable resolution according to the real time network environment.
4. Q: Motion detect set and alarm?
A: 1). Set motion detect sensitivity in Alarm Config, and press right corner Confirm to save the setting;
2). When motion detected, camera will push a alarm message to your phone and take one picture for checking in the APP [Page 15 - Alert notification]. (A micro sd card MUST be inserted for saving alarm pictures)

19

5. Q: Micro SD card instruction?
A: 1). Format card before inserting;
2). When backside switch is on, every time you insert micro SD card, it will record automatically;
3). Once connected, can set SD management in app [Micro SD Card Record Config].
4). If Micro SD card detected and recording, the Wi-Fi indicator will flash slowly.
6. Q: How to play micro SD card video?
A: 1). Use a card reader to read and play;
2). Use APP to play back [Page 13 - TF card recorded files];
3). Play back in good speed network.
7. Q: Forget camera password, or item goes abnormal?
A: Turn on camera and wait for 1 minutes, press reset key around 10 seconds till back indicators off to restore factory default. Camera restarts and get ready again in 1 minutes.
8. Q: Any operation video demo of the camera for setting up?
A: Please contact local dealer for video guide.

20

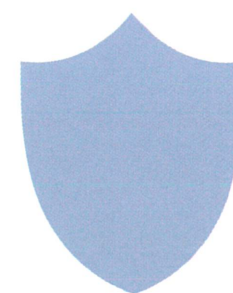

The end!